



Leemac

MODEL : RH02-520 SERIES

SPECIFICATIONS

MOTORS	1
SPEED	3
AIRFLOW	850 m ³ /h
MOTOR ABSORPTION	205 Watts
LIGHTS HALOGEN	2 X 20 Watts
NOISE LEVEL	62 (dB)
DUCT SIZE	150 mm Dia

- * Stainless Steel
- * Aluminium filters (Dishwasher Safe)
- * Twin Halogen Lights
- * Turbo Motor
- * 522 mm wide Recessed Hood

ACCESSORIES

- Carbon Filters F-C 18(1 pair)

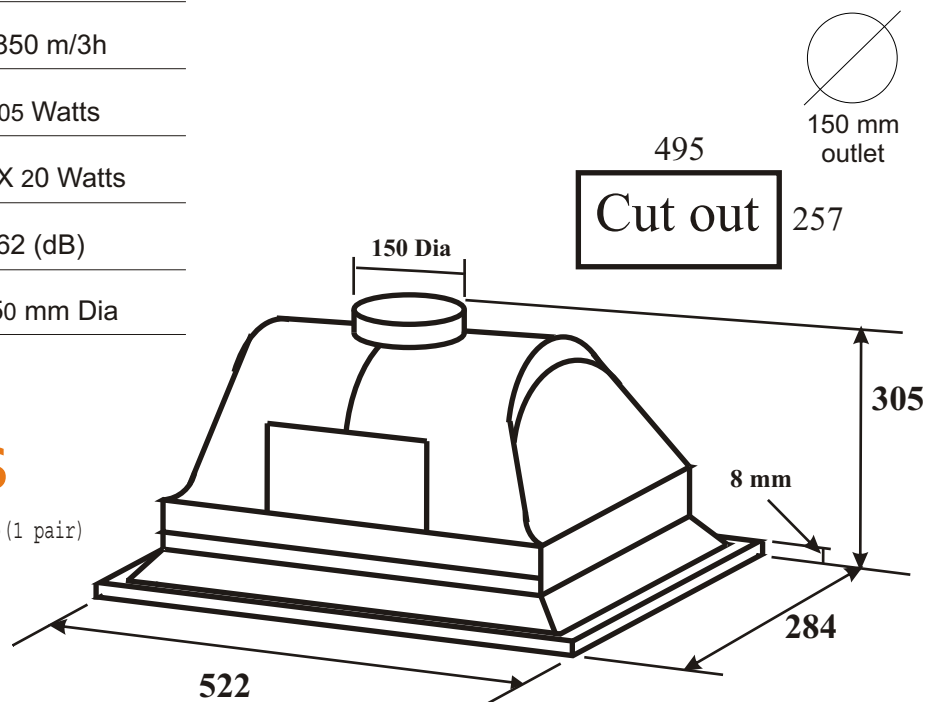

LEEMAC APPLIANCES
 U28 / 14 - 16 STANTON ROAD
 SEVEN HILLS NSW 2147
 AUSTRALIA
 PH - 02 9674 9955
 FAX - 02 9674 9055

RH 02-520

Email-pezooffice@leemac.com.au Web-www.leemac.com.au